



Interior Glass Door Solutions

- Office Enclosures
 - Partitions
 - Flexible Room Dividers
- Sliders Suspended Barn Doors Bi-Fold Doors Swing Doors

FLEXIBLE WORKSPACES HAVE ARRIVED

We are proud to make interior glass doors in our own factory where safety and quality are fabricated into every single panel. The variety of systems, glass types, frame finishes, and accessories provide our clients with simple, functional, and stylish choices to suit their specific needs. Allowing natural light to come in while stopping unwanted foot traffic in private work areas easily boosts morale and productivity. Another benefit from The Sliding Door Company; we have solved the challenge of needing each office front master-keyed, keyed-alike, or individually which speaks volumes for building developers, property managers, and company owners, not to mention our solutions can be master keyed to store front too!





COWORKING SPACES

Our diverse assortment of glass partitions that foster teamwork and innovation coupled with private office enclosures that lock creates the perfect balance within any environment. Our transformative workspaces are crafted from the highest grade materials, designed to create a more flexible and functional environment. Glass walls and partitions allow for natural light and easy customization to optimize functionality. Revolutionary systems including sliders, swing doors, bi-folds, fixed glass walls and suspended solutions provide privacy on demand.

COLLABORATIVE WORK SPACES

Work spaces to inspire your team!

Create a place to make a life, not just earn a living. People spend so many hours at work, the environment should be inspiring, motivating, and foster creativity, teamwork and strong cross-functional relationships.

Optimize functionality within a space so people can do their best work. Include the perfect balance of wide open spaces and locked offices for those who need them.

Building to our client's specific project requirements is the hallmark of the way we build relationships.



HOSPITALITY SOLUTIONS NOW ACCOMMODATING FIVE STAR FLEXIBILITY

Take banquet rooms, hotel lobbies, restaurants, and business centers to new heights with privacy on the fly. Our variety of sliding, swing, fixed, and glass room dividers cater to a patron's evolving needs, enhancing the dynamic usability of space while providing an uplifting environment that maximizes natural lighting and minimizing costs.

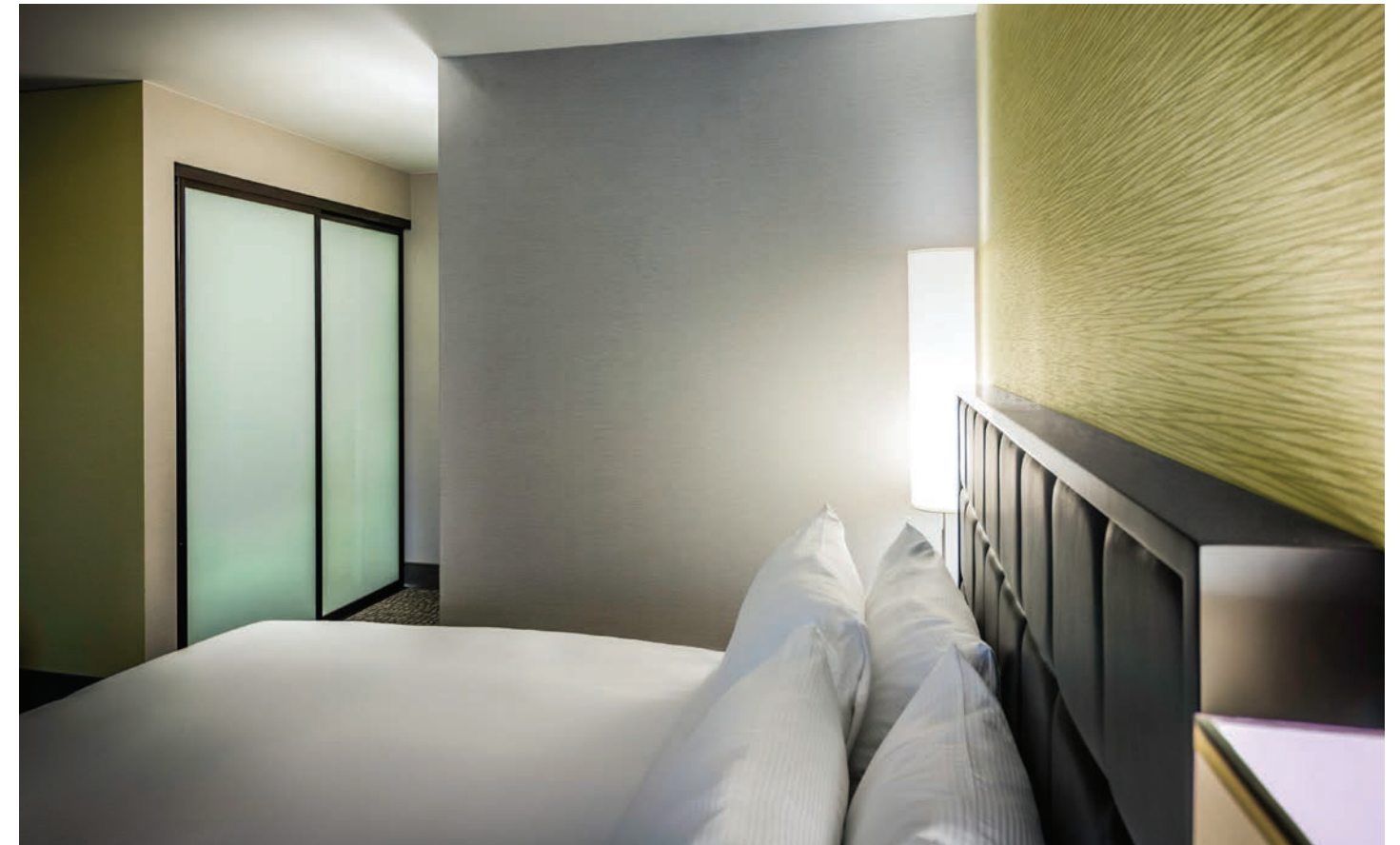

MULTI-UNIT RESIDENTIAL SOLUTIONS

Maximize your property's floor plan with our sliding, stacking, and stationary glass closet doors and room dividers. Add value to residential developments, condos, lofts, and apartments with incredible style, flexibility, and the best lead-time in the industry.





HEALTHCARE SOLUTIONS

BRIGHTEN THE PATIENT'S EXPERIENCE

From lobbies to patient rooms, our factory to field turnkey solutions will boost morale throughout the process.

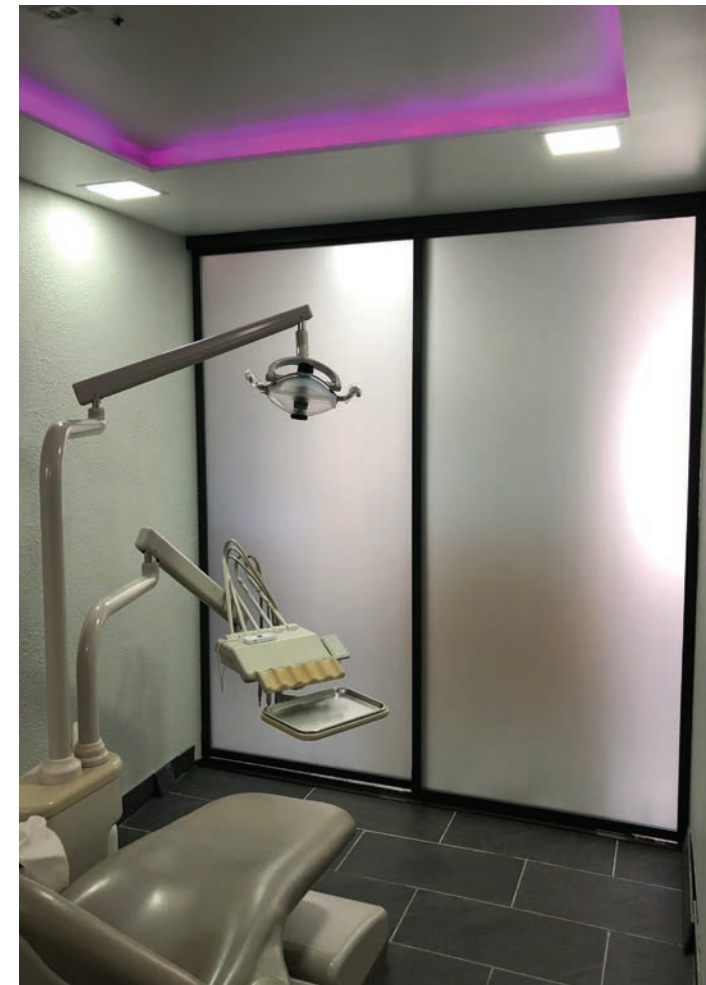
- Visual privacy and allows for natural light
- Environmentally Friendly product line (architects can capitalize on up to 14 LEED points when our product line is incorporated into the project).
- ADA compliance



- ADA  compliant accessories, locks, latches, push pressure, low profile track
- Suspended system options, no bottom track
- Glass can be cleaned on both sides for optimum patient conditions
- Master key options available for cleaning personnel, IT team, etc.

ENVIRONMENTALLY FRIENDLY SOLUTIONS BOOST MORALE BY LETTING TONS OF NATURAL LIGHT IN

We are proud to be a part of huge efforts towards producing, assembling, shipping and installing state of the art interior glass door solutions in support of our nation's focus on preserving the environment. Our products are made primarily of glass and aluminum which are both recyclable. The innovative design and production procedures preserve the environment from the beginning of the process right through installation and use in your new or existing office, residence or tenant improvement projects.

Since our products do not require any harsh chemicals for cleaning, we also help preserve indoor air quality at all times while keeping maintenance to an absolute minimum.

MATERIALS AND RESOURCES

The Sliding Door Company uses materials with the least environmental impact at both the production and installation stages.

Due to the simplicity of our product line, we use very few materials and keep the installations easy with no full construction required.

The aluminum extrusions are made with all new raw materials and are fully recyclable.

INDOOR ENVIRONMENT QUALITY – SAFETY DATA

Our entire product line helps commercial and residential clients alike to reduce and manage sources of indoor pollutants.



We give occupants a strong connection to the outdoor environment as light comes through our interior glass door solutions while they still provide visual privacy and curtail foot traffic.

There are no hazardous wastes to deal with and no materials that emit chemicals into the air.

Mitered bottom track next to 4x4 vertical post.

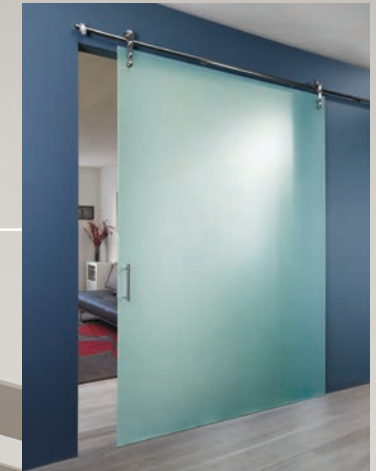
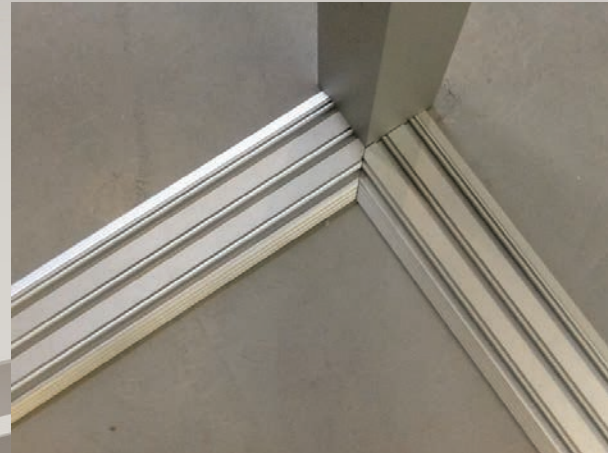

Room Dividers Create a truly showcase conference room. Open the panels to create the feeling of space. Close them for privacy. Choose the frame color, glass types, and style to fit your vision. Panels are the quietest, smoothest gliding in the industry. Just slide and divide.

Wall Slide Doors Give your office the "wow" factor with these space-saving doors. With our chic styles, contemporary frame colors, and beautiful glass types, they're just too beautiful to hide.

Suspended Systems Give your office entrance the cleanest look ever with no bottom track.

Office Partitions Flexibility is a hallmark of our office partitions. Walls can open, close, or be made stationary. Choices of finishes, sizes, glass types, frame styles, and hardware are practically endless.

ROOM DIVIDERS

Create privacy on demand with a room divider that stacks to open and slides nearly silently to close. Space saving solutions enhance functionality in offices, classrooms, hospitals, hotels, and multi-unit lofts and just about any office space you can think of. The light smooth glide is made possible from our patented upper rollers and the sturdy design of our flexible track system. The tracks can be installed on top of finished flooring, recessed, or ramped! The low profile tracks are ADA compliant and made of anodized aluminum.

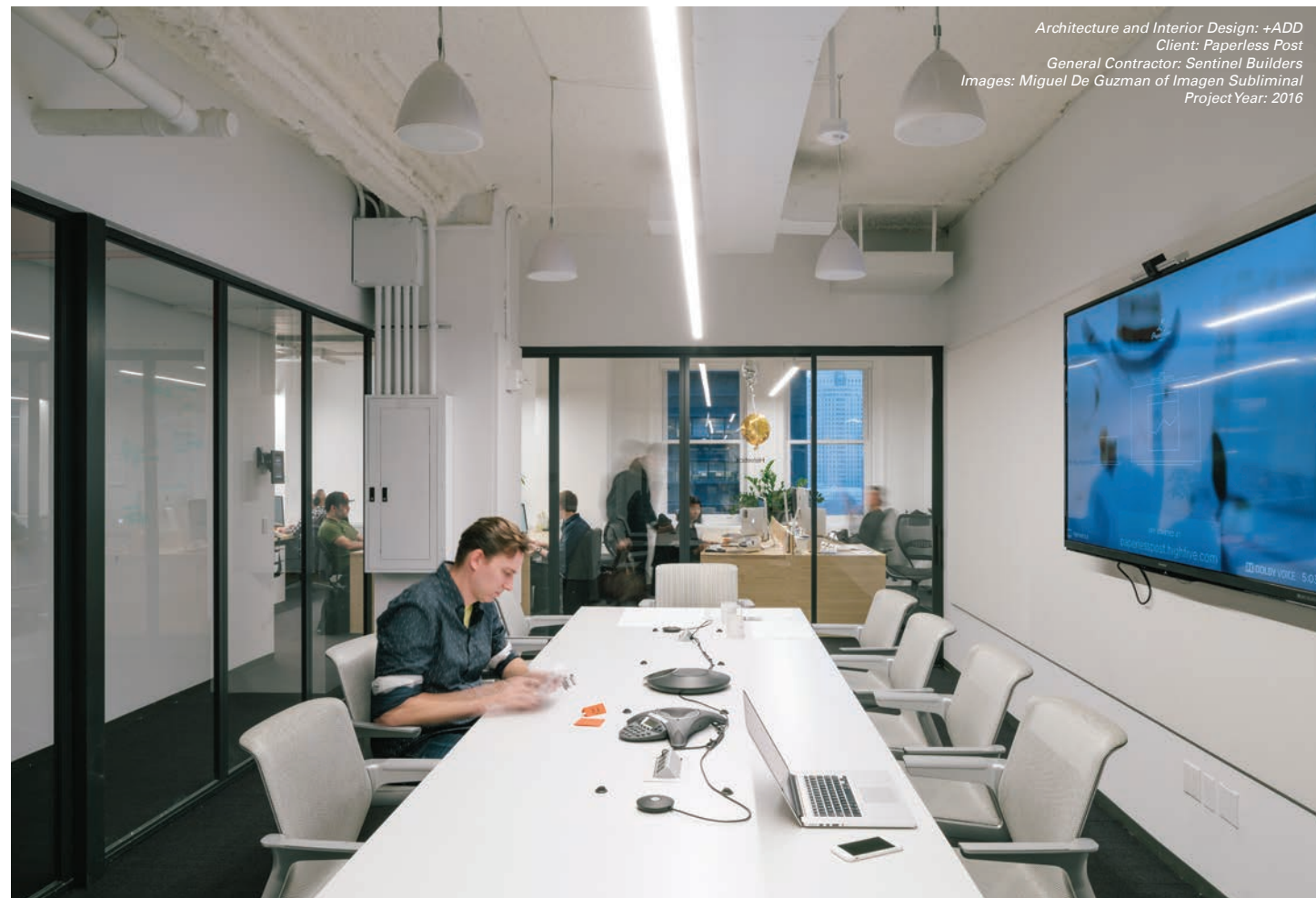

OFFICE PARTITIONS & PHONE BOOTHS

Optimize your space with floor to ceiling or open air office partitions. Available with various track, glass types, accessories, and frame options. Improve the productivity and atmosphere with collaborative solutions that will allow teams to create and innovate. (Sliders, bi-fold, fixed, swing)





GLASS WALLS

Flexibility is in demand for offices, hospitality, education, government, healthcare, and multi-unit environments. Customizable glass walls offer visual privacy without compromising collaboration.

FRAMELESS AND SUSPENDED GLASS BARN DOORS

Since every inch of space counts these solutions with no bottom track add value beyond doors.

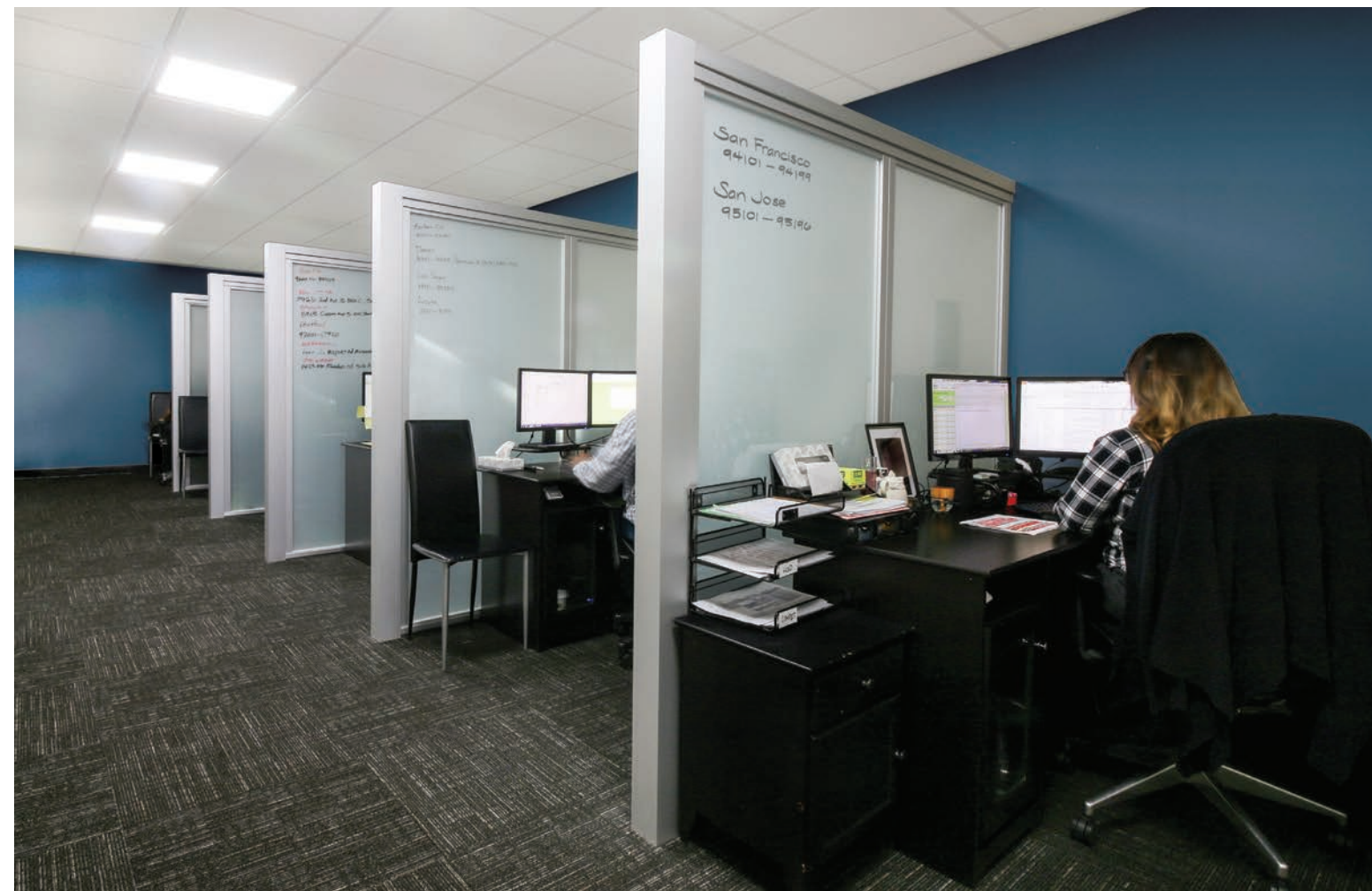

SWING DOORS

Our durable swing doors with top hinge and bottom pivot are a unique deviation from traditional side-hinge doors. Choose from a variety of glass types, frame finishes, designer handles, and locks that can be master keyed (even to your store front!) The fixed glass panels and transom are the perfect companions for the swing doors shown here as they allow for plenty of natural light to shine through while still maintaining privacy with locked doors when needed.





SUSPENDED SYSTEMS

Today's offices, homes, and multi-use spaces benefit from bottomless track door solutions. Functional, Stylish, Flexible.



KEYLESS ENTRY

Make life easier with keyless entry. With the Lockitron Bolt for businesses, you don't have to worry about fishing around in your bag or pocket for your key or keycards, or worry about having to memorize complicated codes. Now, unlocking your door can be as easy as a simple touch of your phone.

Imagine giving a "one time contractor" access for only as long as the project needs it. No more changing locks or access codes. This flexibility is super convenient, safe, and trackable.



Lockitron Bolt for Sliders



Lockitron Bolt for Swing Doors

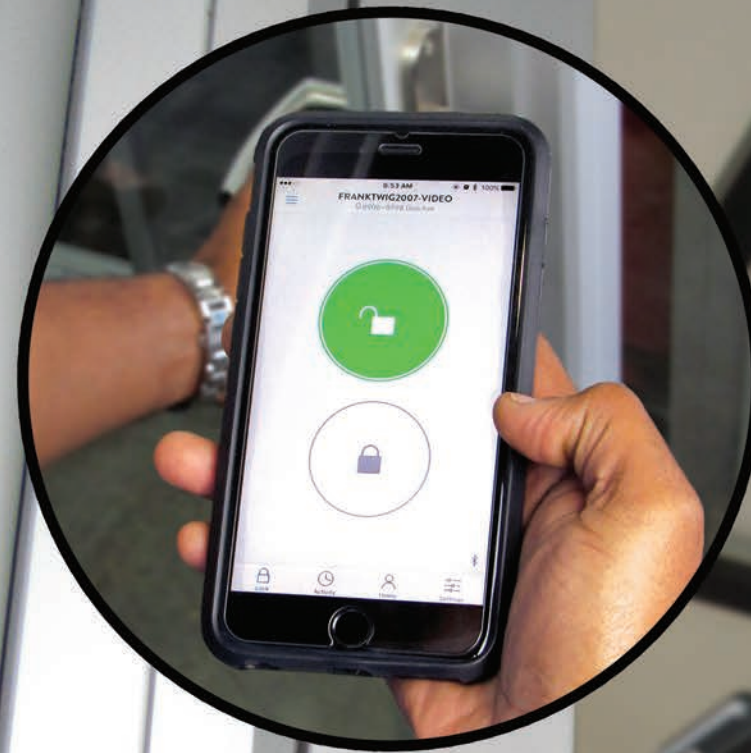

PASS-THROUGH WINDOWS

Enjoy the flexibility of easy opening for interaction and communication, and the ability to lock for added security.



INNOVATIVE PATENTED DESIGN

Ultimate safety has been our main focus since day one. Our patented panel safety mechanism features a unique sliding panel-to-track locking mechanism that ensures our doors will not leave their tracks.



Smoothest and quietest wheels

We only feature the **highest quality materials**. Our patented upper roller system is an instrumental part of nearly silent glide.



Patented system

SAFETY: our **patented Wheel-To-Track Locking Mechanism** ensures panels will not leave the tracks (shown here without wheel cover).

Where Are The Wheels™

ASK WHY IT MATTERS!

THE SLIDING DOOR COMPANY
Interior glass door solutions

FLEXIBILITY

Tracks can be installed on top of flooring, recessed, or with ramps.

Quad Regular (or Recessed): (4) Single Bottom Tracks+ (3) Bottom Track Connectors

Quad Ramped: (4) Single Bottom Tracks+ (3) Connectors+ (2) Ramps

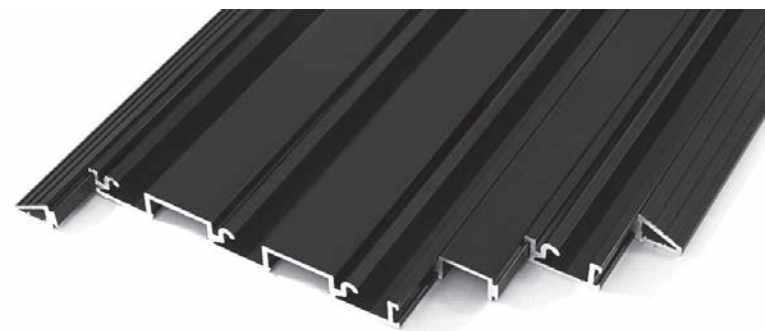

Bottom Track Install Options

Low profile bottom track: 3/8" in height.

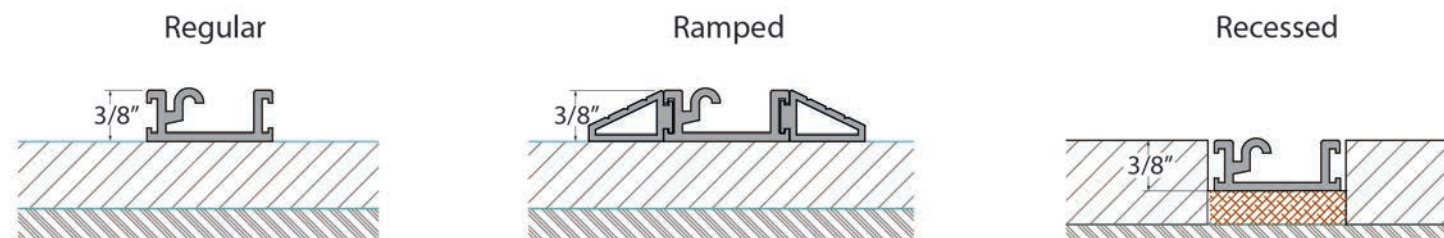

SMART TRACK SYSTEM

Get the choices you need to achieve your project goals.

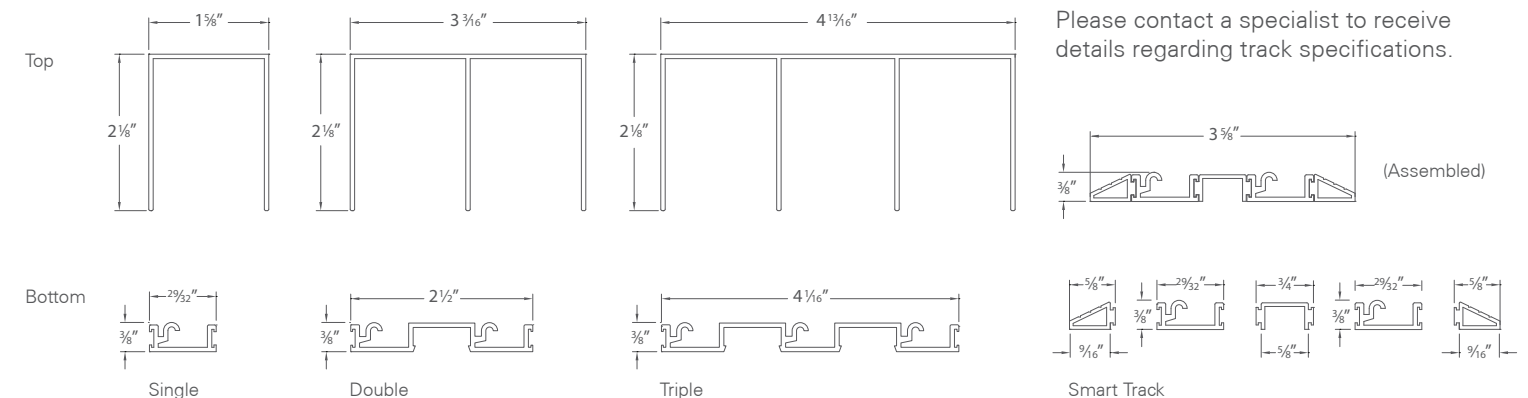

GLASS TYPES

SLIDE INTO A WORLD OF GLASS OPACITY TO CHOOSE FROM



Tint of glass may be influenced by surrounding lighting and interiors.

HANDLES AND LOCKS



Using an ADA compliant handle does not necessarily mean that the whole system is ADA compliant, Architects/Contractors/Clients should check state codes.

FRAME FINISHES

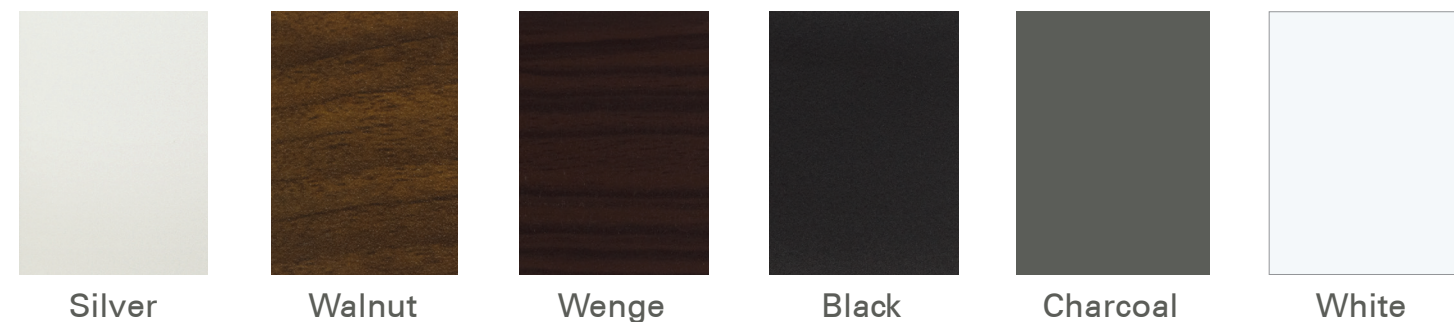

PANEL DESIGNS (DIVIDER STRIPS AND SUPPORT DIVIDERS)

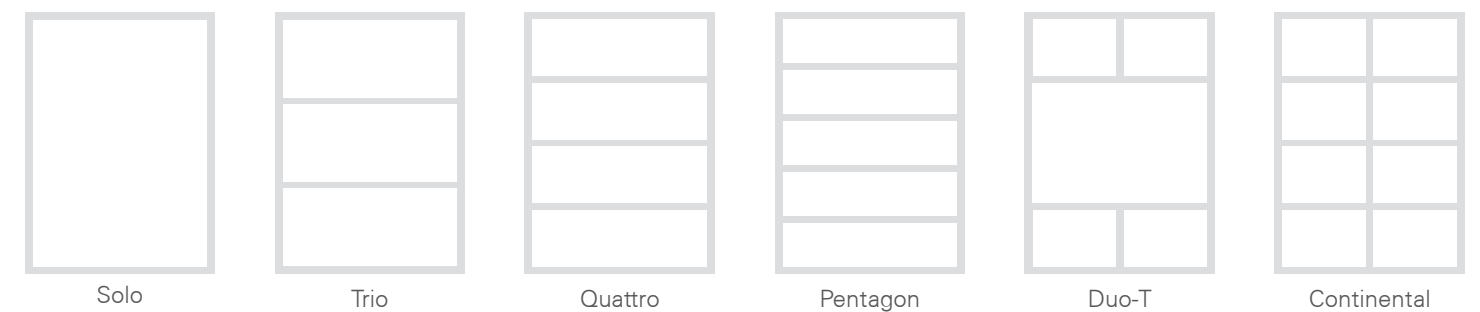

CONTACT A SPECIALIST TODAY

WEST COAST

CHATSWORTH

20235 Bahama St.
Chatsworth, CA 91311
t 818 997 7855

COSTA MESA

3323 Hyland Ave. Unit G-2
Costa Mesa, CA 92626
t 714 754 7010

CULVER CITY

8684 Washington Blvd.
Culver City, CA 90232
t 424 298 8209

PASADENA

2614 E. Colorado Blvd.
Pasadena, CA 91107
t 626 689 2200

PHOENIX

14891 N. Northsight Blvd.
Scottsdale, AZ 85260
t 480 887 8720

SAN DIEGO

2210 4th Ave.
San Diego, CA 92101
t 619 692 1294

SAN FRANCISCO

680 8th St., Suite #163
San Francisco, CA 94103
t 415 626 2622

SAN JOSE

355 South 1st St.
San Jose, CA 95113
t 408 642 1571

SEATTLE

5963 Corson Ave. S #102
Seattle, WA 98108
t 206 467 1869

MIDDLE U.S.

CHICAGO

221 W. Ohio St.
Chicago, IL 60654
t 312 494 9494

DENVER

601 S. Broadway, Unit Y
Denver, CO 80209
t 303 744 0489

HOUSTON

t 713 850 0707

EAST COAST

ATLANTA

1737 Ellsworth Industrial Dr.
Suite C-1
Atlanta, GA 30318
t 770 988 4733

BOSTON

409 Harrison Ave.
Boston, MA 02118
t 617 982 6700

FORT LAUDERDALE

913 NE 4th Ave.
Fort Lauderdale, FL 33304
t 954 923 5252

MANHATTAN

230 5th Ave. Ground Floor
New York, NY 10001
t 212 213 9350

WASHINGTON D.C.

2127 14th NW
Washington, DC 20009
t 202 588 8840

ALASKA

ANCHORAGE

Spensard Builders Supply
4412 Lois Dr.
Anchorage, AK 99517
t 907 261 9280
Authorized Distributor

PACIFIC

HONOLULU

4211 Waiialae Ave. #1040
Kahala Mall
(Inside California Closets)
Honolulu, HI 96816
t 808 529 1580

PHILIPPINES

MANILA

Sliding Doors Asia Pacific, Inc.
(SDAPI)
Unit 20, 2F, Two Maridien
26th Street Corner 9th Ave
Bonifacio Global City,
Taguig, 1634, Philippines
t +632 7617 6882
c +63 917 720 1032
www.slidingdoor.com.ph

CANADA

BURLINGTON

Domilya Group
4380 South Service Rd., Unit 11
Burlington, ON L7L 5Y6
t 833 366 4592
Authorized Distributor

CALGARY

526-42nd Ave. SE
Calgary, AB T2G 1Y6
t 403 451-5782

EDMONTON

RSVP Design Inc.
4552-99 Street
Edmonton, AB T6E 5H5
t 780 452 3753
Authorized Distributor

MONTREAL

1079 Rue Bégin
Saint-Laurent, Québec H4R 1V8
t 514 375 0139

TORONTO

75 Ingram Dr.
Toronto, ON M6M 2L7
t 416 637 4620

VANCOUVER

1618 W. 3rd Ave.
Vancouver, BC V6J 1K2
t 778 371 1511

MORE TO COME
Visit our website for
the latest updates.



CUSTOMER SERVICE: 818 534 2344

www.slidingdoorco.com